



# PRODUCT SPECIFICATION

## Model No.: CSDS-2D107VMB

Descriptions:
<ul style="list-style-type: none"> <li>■ 2.3 Inch Single Digit Display</li> <li>■ Common Cathode</li> <li>■ Emitting Color: Rich Color(Red,Green,Blue)</li> <li>■ Black Face</li> <li>■ White Segment</li> </ul>



CUSTOMER APPROVED SIGNATURES	APPROVED BY	CHECKED BY	PREPARED BY

**CHINA SEMICONDUCTOR CORPORATION**  
Address:2FL. NO.909,Chung-Cheng Road,  
Chung-Ho City Taipei Hsien,Taiwan.

Tel:886-2-2223-9696  
Fax:886-2-2223-9377

**OPTO PLUS TECHNOLOGIES CO.,LTD**  
Address:696 Shun jiang Rd.,Shaoxing,  
ZheJiang,China

Tel:86-0575-88623888  
Fax:86-0575-88623112



**Model No.: CSDS-2D107VMB**

**Features -**

1. 2.3 inch (56.80mm) digit height.
2. Case mold type.
3. RoHS compliant.
4. Low power consumption.
5. Standard: black face, white segment.
6. Easy mounting on P.C. board or socket.

**Device Selection Guide -**

Model No.	Chip		Description
	Material	Emitting Color	
CSDS-2D107VMB	AlGaInP	Super Bright Orange	Common Cathode
	InGaN	Super Bright Pure Green	
	InGaN	Super Bright Blue	

**Mechanical Dimensions -**

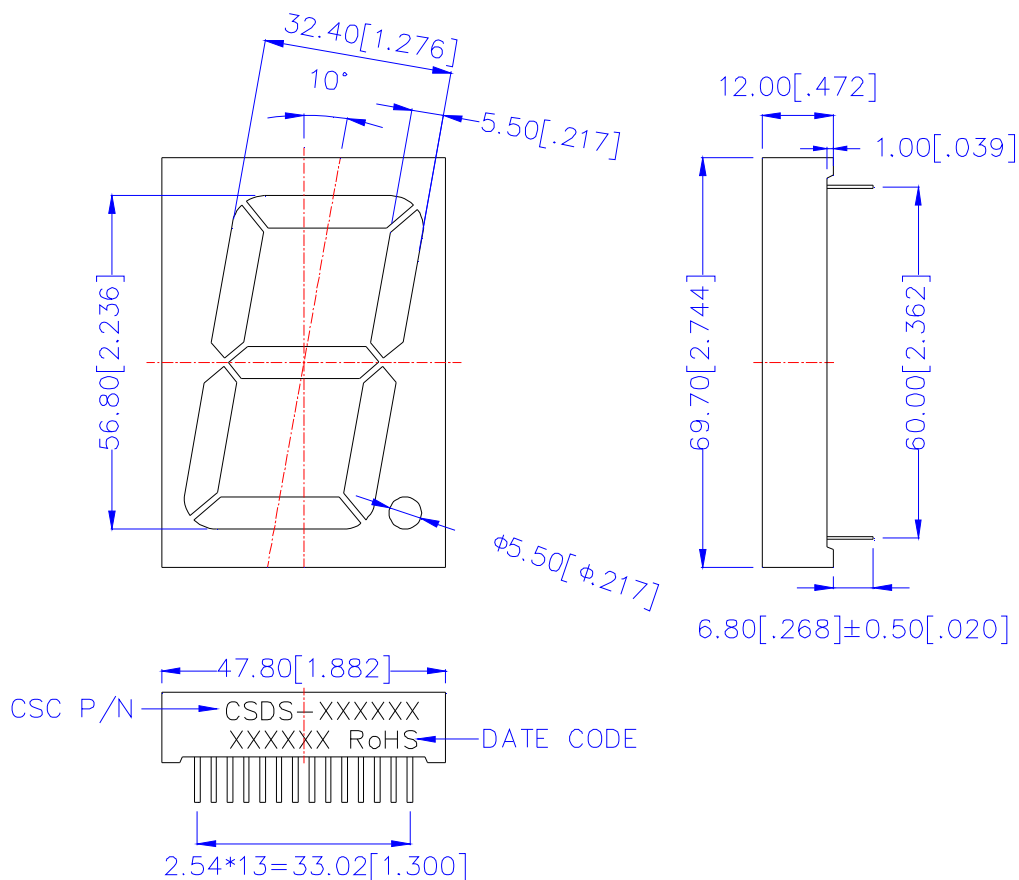

**Notes:**

1. All pins are  $\phi 0.60$  [.024]
2. Dimension in millimeter [inch], tolerance is  $\pm 0.25$  [.010] and angle is  $\pm 1^\circ$  unless otherwise noted.
3. Bending  $\leq$  Length\*1%.



Model No.: CSDS-2D107VMB

Internal Circuit Diagrams -

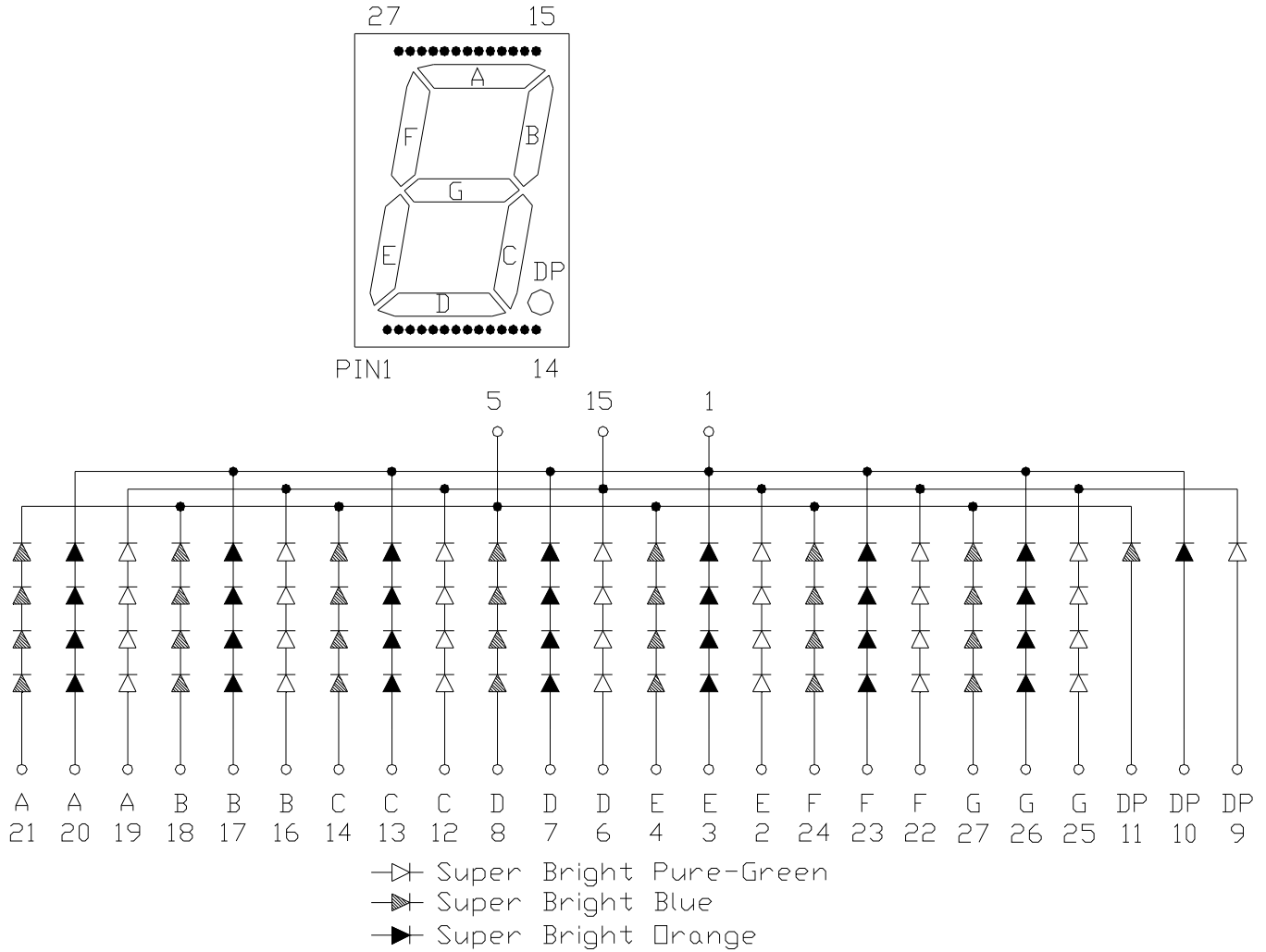



**Model No.: CSDS-2D107VMB**

■ **Absolute Maximum Rating -**

Super Bright Orange		(Ta=25°C)	
Parameter	Symbol	Rating	Unit
Power Dissipation Per Dice	P <sub>AD</sub>	70	mW
Derating Liner from 25°C per Dice	-	0.33	mA/°C
Continuous Forward Current Per Dice	I <sub>AF</sub>	25	mA
Peak Current Per Dice(duty cycle 1/10,1KHz)	I <sub>PF</sub>	90	mA
Reverse Voltage Per Dice	VR	5	V
Operating Temp.	Topr	-35 ~ +85	°C
Storage Temp.	Tstg	-35 ~ +85	°C

Super Bright Pure Green		(Ta=25°C)	
Parameter	Symbol	Rating	Unit
Power Dissipation Per Dice	P <sub>AD</sub>	114	mW
Derating Liner from 25°C per Dice	-	0.4	mA/°C
Continuous Forward Current Per Dice	I <sub>AF</sub>	30	mA
Peak Current Per Dice(duty cycle 1/10,1KHz)	I <sub>PF</sub>	100	mA
Reverse Voltage Per Dice	VR	5	V
Electrostatic discharge(HBM)	ESD	1	KV
Operating Temp.	Topr	-35 ~ +85	°C
Storage Temp.	Tstg	-35 ~ +85	°C

Super Bright Blue		(Ta=25°C)	
Parameter	Symbol	Rating	Unit
Power Dissipation Per Dice	P <sub>AD</sub>	114	mW
Derating Liner from 25°C per Dice	-	0.4	mA/°C
Continuous Forward Current Per Dice	I <sub>AF</sub>	30	mA
Peak Current Per Dice(duty cycle 1/10,1KHz)	I <sub>PF</sub>	100	mA
Reverse Voltage Per Dice	VR	5	V
Electrostatic discharge(HBM)	ESD	1	KV
Operating Temp.	Topr	-35 ~ +85	°C
Storage Temp.	Tstg	-35 ~ +85	°C



**Model No.: CSDS-2D107VMB**

**Electro-optical Characteristics -**

(Ta=25°C)

Super Bright Orange						
Parameter	Symbol	Min.	Typ.	Max.	Unit	Condition
Forward Voltage Per Segment(DP)	V <sub>F</sub>	-	8.0(2.0)	11.2(2.8)	V	I <sub>F</sub> =20mA
Luminous Intensity Per Segment	I <sub>v</sub>	94	234	-	mcd	I <sub>F</sub> =10mA
Peak Emission Wavelength	λ <sub>P</sub>	-	632	-	nm	I <sub>F</sub> =20mA
Dominant Wavelength	λ <sub>d</sub>	-	624	-	nm	I <sub>F</sub> =20mA
Spectrum Radiation Bandwidth	Δ λ	-	20	-	nm	I <sub>F</sub> =20mA
Reverse Current(DP)	I <sub>R</sub>	-	-	100	μA	V <sub>R</sub> =20(5)V
Luminous Intensity Matching Ratio	IV-m	-	-	2:1	-	I <sub>F</sub> =10mA

Super Bright Pure Green						
Parameter	Symbol	Min.	Typ.	Max.	Unit	Condition
Forward Voltage Per Segment(DP)	V <sub>F</sub>	-	12.8(3.2)	15.2(3.8)	V	I <sub>F</sub> =20mA
Luminous Intensity Per Segment	I <sub>v</sub>	150	375	-	mcd	I <sub>F</sub> =10mA
Dominant Wavelength	λ <sub>d</sub>	-	525	-	nm	I <sub>F</sub> =20mA
Spectrum Radiation Bandwidth	Δ λ	-	30	-	nm	I <sub>F</sub> =20mA
Reverse Current(DP)	I <sub>R</sub>	-	-	50	μA	V <sub>R</sub> =20(5)V
Luminous Intensity Matching Ratio	IV-m	-	-	2:1	-	I <sub>F</sub> =10mA

Super Bright Blue						
Parameter	Symbol	Min.	Typ.	Max.	Unit	Condition
Forward Voltage Per Segment(DP)	V <sub>F</sub>	-	12.8(3.2)	15.2(3.8)	V	I <sub>F</sub> =20mA
Luminous Intensity Per Segment	I <sub>v</sub>	58	146	-	mcd	I <sub>F</sub> =10mA
Peak Emission Wavelength	λ <sub>P</sub>	-	468	-	nm	I <sub>F</sub> =20mA
Dominant Wavelength	λ <sub>d</sub>	-	470	-	nm	I <sub>F</sub> =20mA
Spectrum Radiation Bandwidth	Δ λ	-	30	-	nm	I <sub>F</sub> =20mA
Reverse Current(DP)	I <sub>R</sub>	-	-	50	μA	V <sub>R</sub> =20(5)V
Luminous Intensity Matching Ratio	IV-m	-	-	2:1	-	I <sub>F</sub> =10mA



Model No.: CSDS-2D107VMB

■ Typical Electrical / Optical Characteristics Curves -Super Bright Orange

(Ta = 25°C Unless Otherwise Noted)

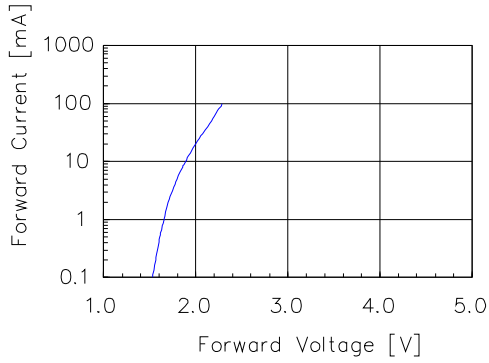

Fig 1. Forward Current vs. Forward Voltage

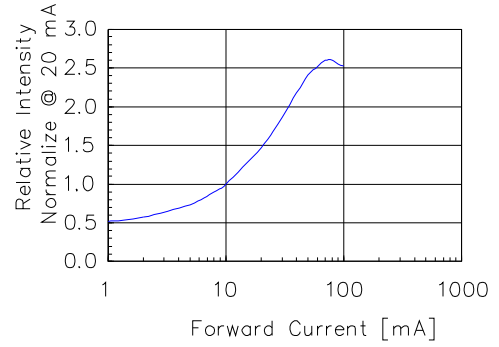

Fig 2. Relative Intensity vs. Forward Current

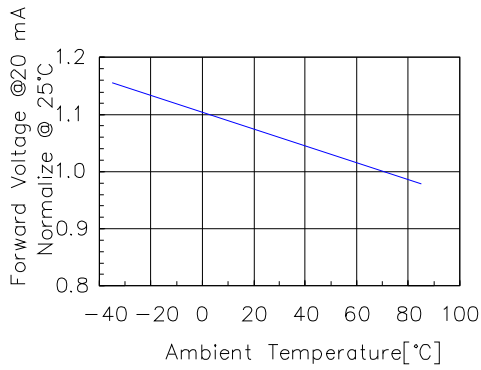

Fig 3. Forward Voltage vs. Temperature

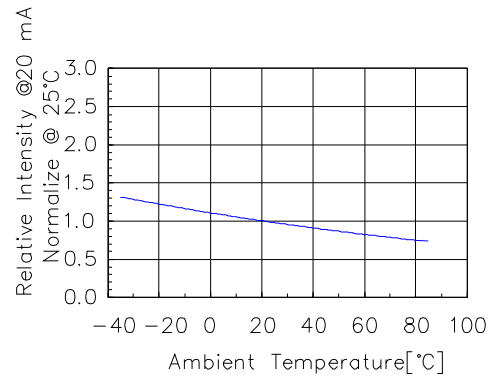

Fig 4. Relative Intensity vs. Temperature

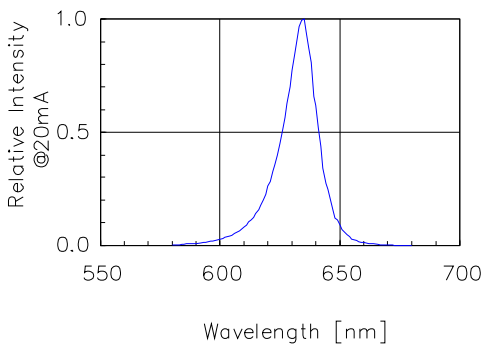

Fig 5. Relative Intensity vs. Wavelength



Model No.: **CSDS-2D107VMB**

● **Super Bright Pure Green**

(Ta = 25°C Unless Otherwise Noted)

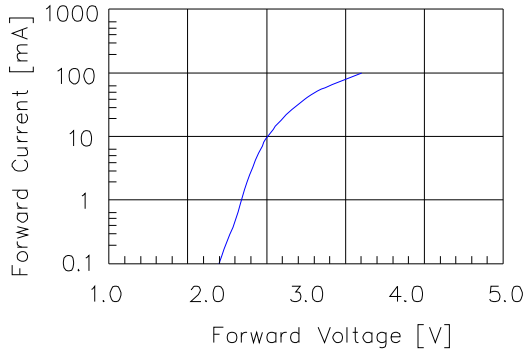

Fig 1. Forward Current vs. Forward Voltage

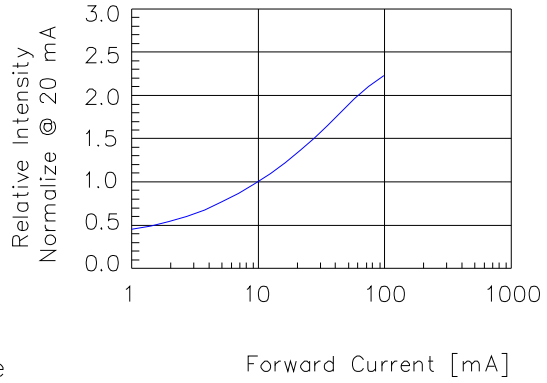

Fig 2. Relative Intensity vs. Forward Current

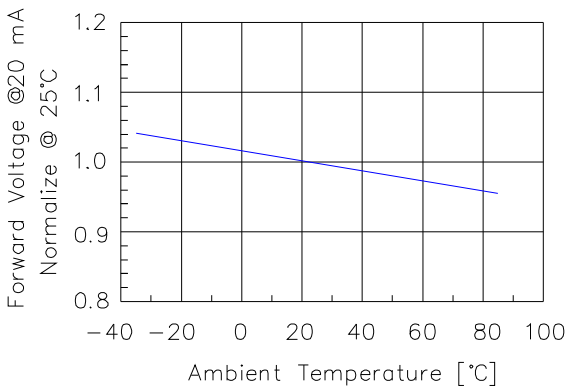

Fig 3. Forward Voltage vs. Temperature

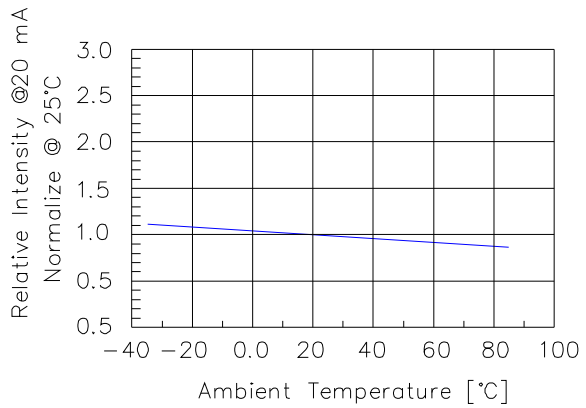

Fig 4. Relative Intensity vs. Temperature

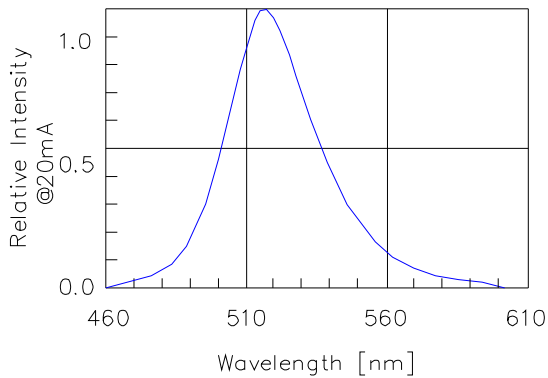

Fig 5. Relative Intensity vs. Wavelength



Model No.: **CSDS-2D107VMB**

● **Super Bright Blue**

(Ta = 25°C Unless Otherwise Noted)

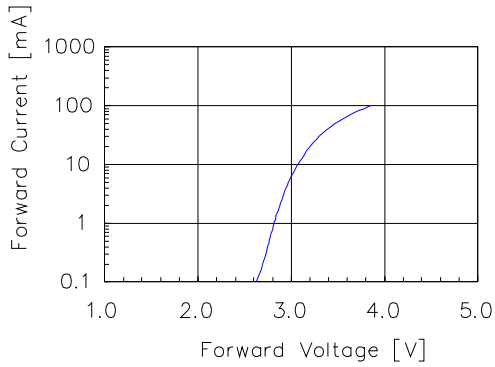

Fig 1. Forward Current vs. Forward Voltage

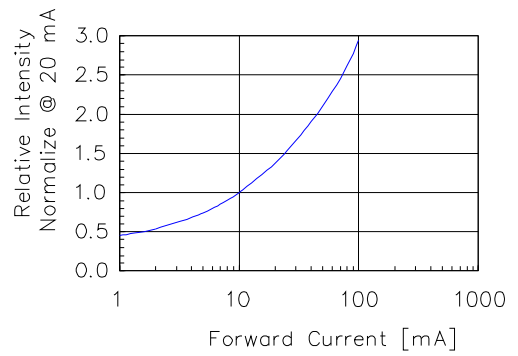

Fig 2. Relative Intensity vs. Forward Current

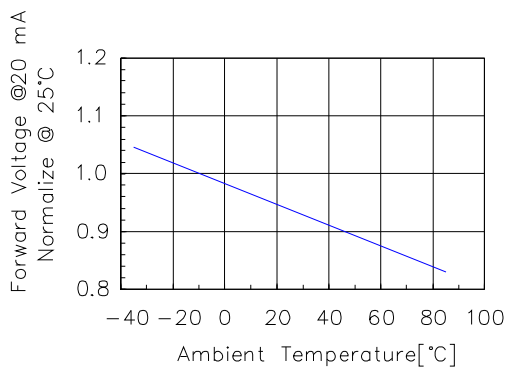

Fig 3. Forward Voltage vs. Temperature

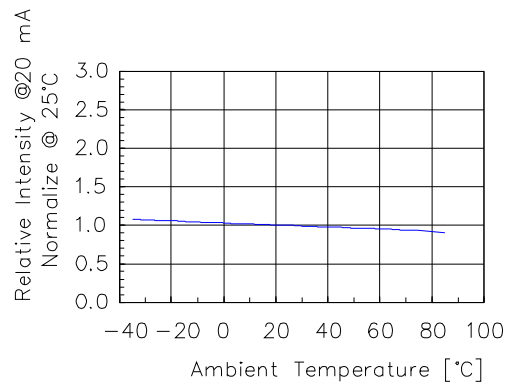

Fig 4. Relative Intensity vs. Temperature

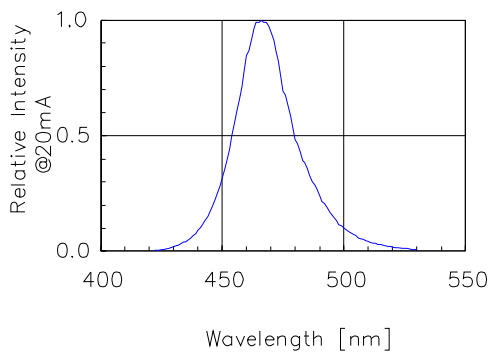

Fig 5. Relative Intensity vs. Wavelength



Model No.: CSDS-2D107VMB

## ■ Precautions For Use -

### 1. Recommended Soldering conditions

#### Wave Soldering

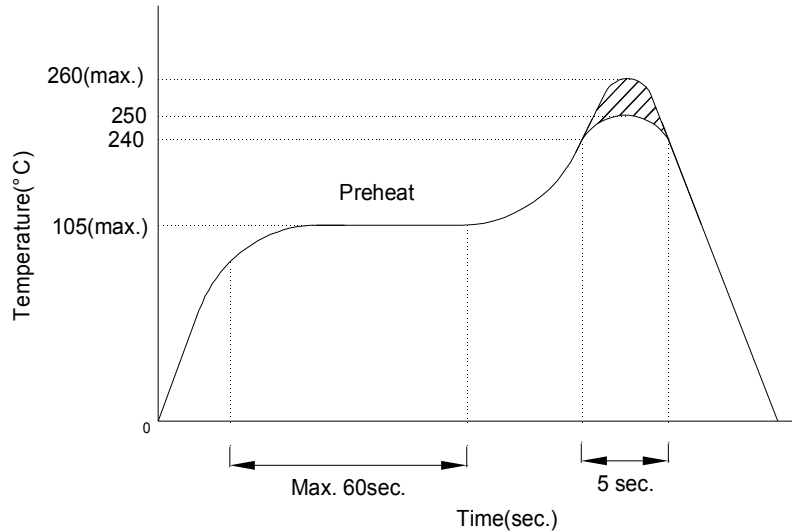

### 2. Soldering Iron

Basic SPEC. is  $\leq 5\text{sec.}$  When  $260^{\circ}\text{C}$ . If temperature is higher, time should be shorter ( $+10^{\circ}\text{C} \rightarrow -1\text{sec.}$ ). Power dissipation of iron should be smaller than 15W, and temperature should be controllable. Surface temperature of the device should be under  $230^{\circ}\text{C}$ .



Model No.: CSDS-2D107VMB

■ Package Dimensions

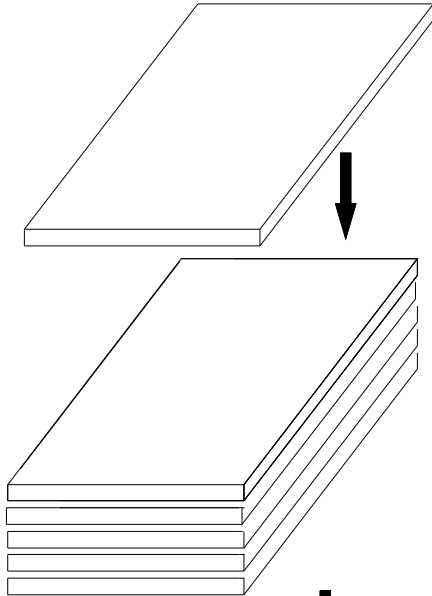

12 Pcs Per PE.foam  
PE.foam Size:  
L295xW195xH15mm

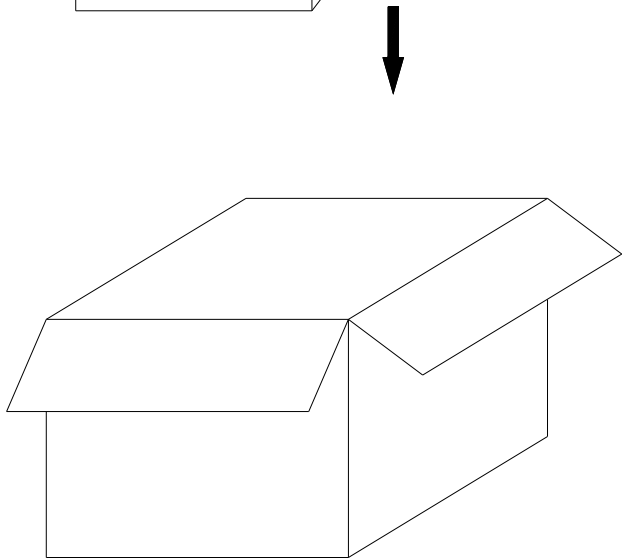

8 PE.foam Per Box  
Q'TY :96 PCS  
Box Size:  
L300\*W205\*H240mm